

BC2204PG1GF-65W

6-Port 10/100/1000M Unmanaged PoE Switch

Datasheet

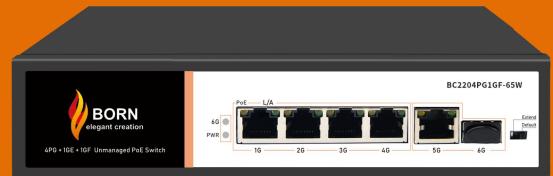

Key Features:

- Ports:** Provide 4*10/100/1000Mbps PoE ports and 1 *10/100/1000Mbps RJ45 and 1*1.25G SFP Uplink
- PoE Standard:** IEEE802.3af/at Power over Ethernet (PoE) Compliant
- Total Power:** Total power budget of 65W and 30W for all single PoE ports
- Self-adaption:** RJ45 port supports 10/100/1000Mbps Auto MDI/MDIX
- Extend Mode:** Extend PoE up to 250m on one single cable
- Wide Application:** Designed for Wifi AP and IP Security camera.VoIP etc
- Surge protection:** Protect the device from lightning surges and others electrical hazards
- Considerate Design:** Exquisite compact size with fanless design
- Easy to use:** Plug and play, No configuration required

Versatile PoE Port

Featuring 4*10/100/1000Mbps PoE ports which support IEEE802.3af/at standard and 1* 10/100/1000Mbps RJ45 and 1* 1.25Gbps SFP Uplink ports. the PoE switch provides Maximun power budget of 65W and 30W for single PoE ports sepectively,allowing users to have several different Networking products configured



Flexible Extend Mode

With the extend mode, the PoE Switch Series is able to offer more flexible choices for long range transmission, extending the distance up to 250m, which is greatly helpful to bring better user experience.

Surge Protection Design

Reaching 6KV surge protection, the PoE ports owns the capacity to keep the PoE Switch from lightning strikes and other electrical surges, offering reliable performance even in some harsh environments.

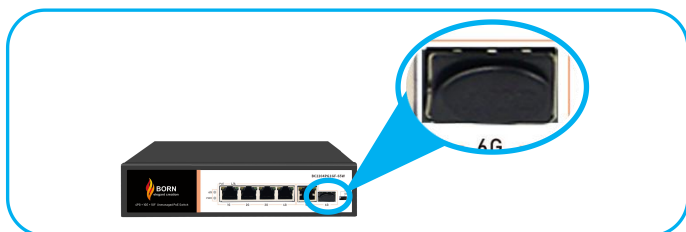
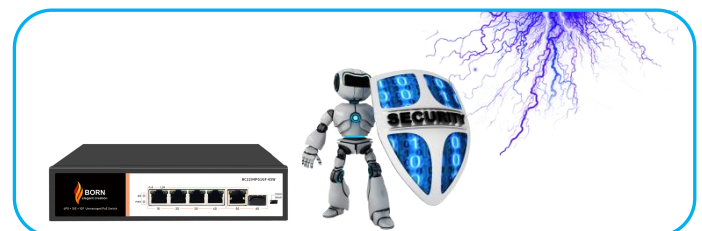

Gigabit SFP Uplink Port

With 1 SFP module slot available, the SFP uplink port is ideal for connecting the switch to the network's backbone, providing more than enough bandwidth and stability for ultra high speed data transferring, Beside the SFP can transmittre the date with Max 100Km distance with more economic solution

BC2204PG1GF-65W

4-Port Gigabit PoE Switch with 1 Gigabit RJ45 and 1 SFP Uplink

Technical Datasheet

Model	BC2204PG1GF-65W	
Hardware Specifications		
Connector	5*10/100/1000BASE-T RJ45 auto MDI/MDIX ports 1*1.25G Base-X SFP Slots	
PoE Port	4*10/100/1000Mbps POE PSE port	
SFP	Single fiber/Dual fiber supported. Distance varies by module	
Thermal Fan	Fanless Design	
LED indicators	Power Indicator: PWR(green). Network Indicator: Link(yellow) PoE Working Indicator: PoE(green) SFP indicator: ON/OFF	
Switch Architecture	Store and Forward	
Transmission model	IEEE802.3X full-duplex and Backpressure half-duplex	
Switch Performance	Backplane bandwidth	12Gbps
	Packet forwarding rate	8.93Mpps
	MAC address	8k
Power requirement	AC100-240V 50/60Hz DC52V/1.25A	
ESD Protection	6KV ESD	
Dimension(WxDxH)	202mm x 140mm x 44.5mm(7.95in x5.51in x 1.75in)	
Weight	0.9Kg	
Power over Ethernet (PoE) Specifications		
Network standard	IEEE802.3i 10 BASE-T	
	IEEE802.3u 100 BASE-TX	
	IEEE802.3x Flow Control	
	IEEE802.3af Power over Ethernet	
	IEEE802.3at Power over Ethernet	
PoE Standard	IEEE802.3az EEE	
	IEEE 802.3af Power over Ethernet/PSE IEEE 802.3at Power over Ethernet Plus/PSE	
PoE Supply Type	1/2(+), 3/6(-) End-span	
PoE Power Output	Per Port 52V DC, 300mA. max. 15.4 watts (IEEE 802.3af)	
	Per Port 52V DC, 600mA. max. 30 watts (IEEE 802.3at)	
PoE Power budget	65W	
Environment		
Environment specification	Operating temperature: -20°C~55°C, operating humidity: 5%~95%	
	Storage temperature: -40°C~75°C, storage humidity: 5%~95%	
Safety	FCC Part15 Class A,CE,RoHS	

BC2204PG1GF-65W

4-Port Gigabit PoE Switch with 1 Gigabit RJ45 and 1 SFP Uplink

Interfaces

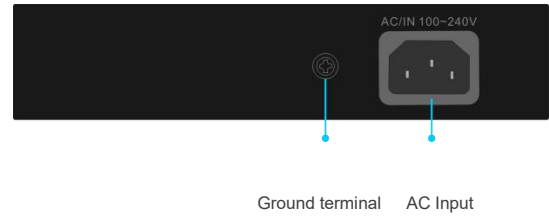
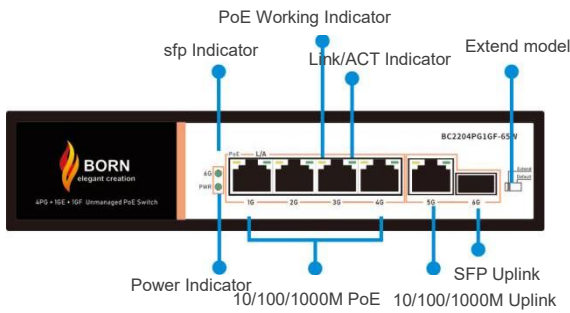

Structure Diagrams

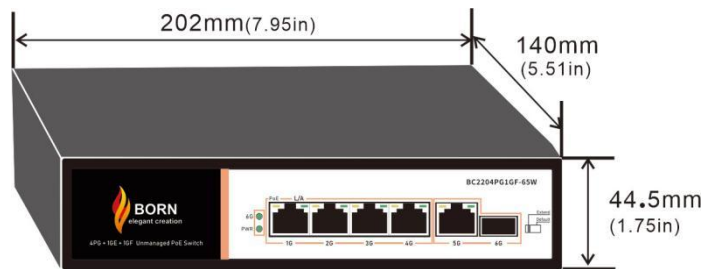

Applications

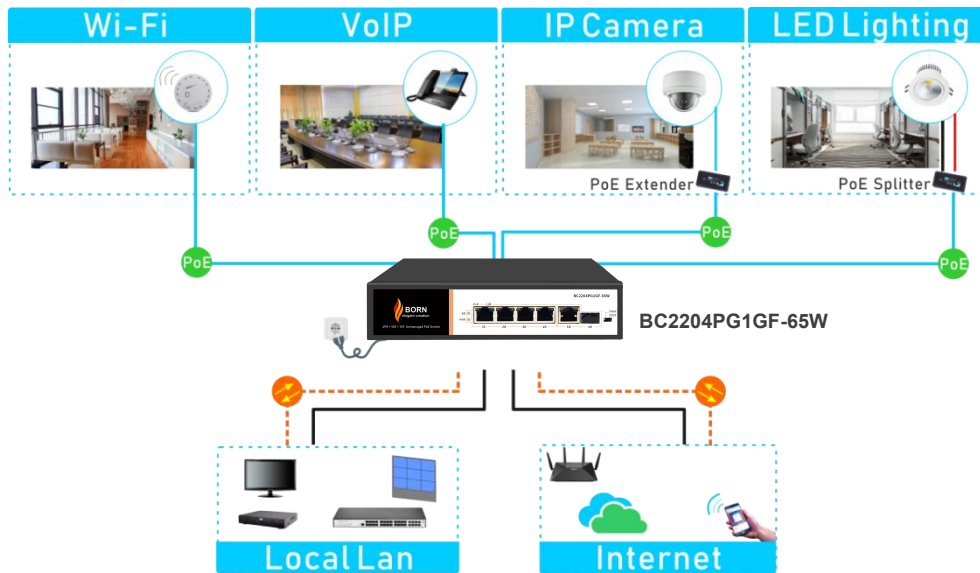

Ordering Information

BC2204PG1GF-65W

4 Ports 10/100/1000Mbps PoE switch with 1Gigabit RJ45 and 1 SFP, 6KV surge protection, IEEE802.3af/at



337 Forest Road
London, United Kingdom



+44 7859 571344



Info@bornelectronics.com



https://bornelectronics.com